

# Dell Laser

## 1710/1710n

Dell:

1.



2.

Dell web,

Dell

[www.dell.com/supplies](http://www.dell.com/supplies)

Dell.



© 2005 Dell Inc.

Dell Inc.

Management System  
Microsoft Corporation.

Dell Inc.



Dell, Microsoft, DELL, Windows

Dell Toner

Dell Inc.

1710/1710n

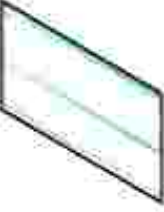
2005 SRV W4213 . A00

<ul style="list-style-type: none"> <li>•</li> <li>•</li> </ul>	<p>CD <i>Drivers and Utilities</i> ( )</p>  <p>Dell ,</p> <p>CD</p>
	
<ul style="list-style-type: none"> <li>•</li> <li>•</li> </ul>	
	

<ul style="list-style-type: none"> <li>•</li> <li>•</li> <li>•</li> </ul>	<p>Web Dell — support.dell.com</p> <p>web Dell</p> <ul style="list-style-type: none"> <li>•</li> <li>•</li> <li>•</li> <li>•</li> <li>•</li> <li>•</li> </ul>
<ul style="list-style-type: none"> <li>• Windows XP</li> <li>•</li> </ul>	<p>Windows XP</p> <ol style="list-style-type: none"> <li>1. Start ( ) → Help and Support ( )</li> <li>2.</li> <li>3.</li> <li>4.</li> </ol>

- \_\_\_\_\_
- \_\_\_\_\_
- \_\_\_\_\_
- \_\_\_\_\_

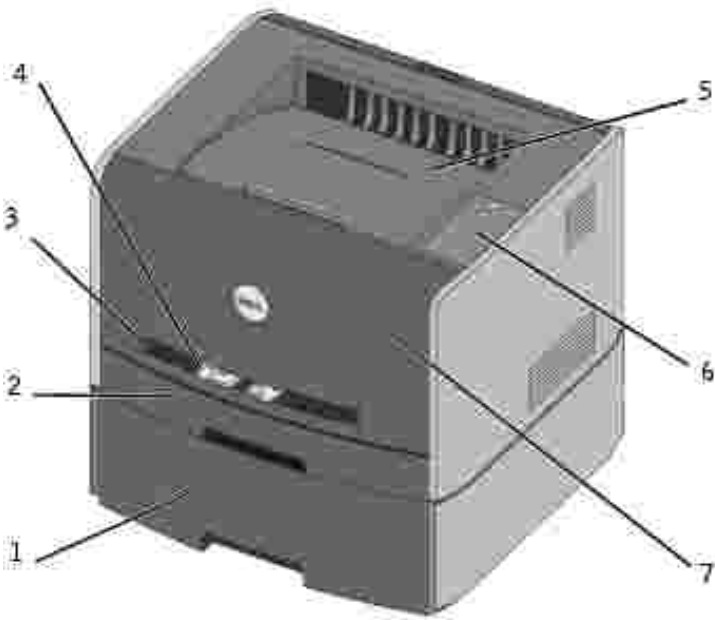





1	550	5	
2	1	6	
3	μ μ	7	μ
4			



μ

μ .



- $\mu$  Continue (  )
- $\mu$  Continue (  )
- $\mu$  Cancel (  )
- $\mu$   $\mu$  Cancel (  )  $\mu$

$\mu$   $\mu$

1.  $\mu$   $\mu$  :
2.  $\mu$  .
3.  $\mu$   $\mu$  Continue (  )
4.  $\mu$  Continue (  ) .
5.  $\mu$  .

6.

Continue (  )

---

Dell Laser 1710

USB	USB 2.0
	IEEE-1284
10/100BaseT Ethernet	CAT-5E

μ

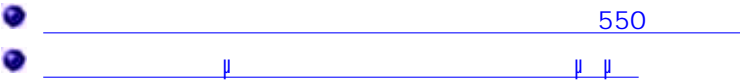

## 550

μ 550



μ 550

1. μ 550
- 2.



3. μ μ 550 μ

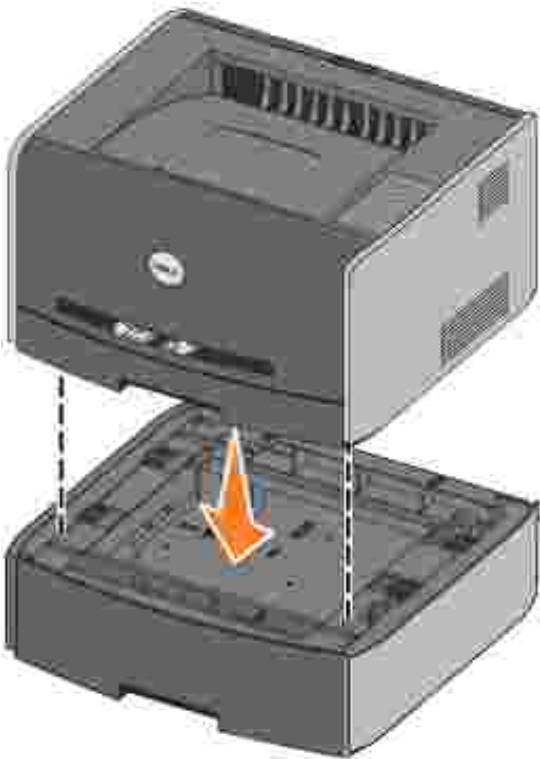



## Dell Laser 1710/1710n

1. Dell Local Printer Settings Utility ( Dell) (Start ( ) → Programs ( ) → Dell Printers ( Dell) → Dell Laser Printer 1710 ( Dell Laser 1710) → Dell Local Printer Settings Utility ( Dell) ).

2. Dell Laser 1710.

3. OK.

4. Paper ( )

5. Tray 1 ( 1).  
1.

6. Tray 2 ( 2).  
2.

7. Menu ( ), Actions ( ) → Apply Settings ( ) .

8. .

9. Local Printer Settings Utility ( )

Windows XP	<ol style="list-style-type: none"> <li>1. Start ( ) →Control Panel ( )→Printers and Other Hardware ( ) →Printers and Faxes ( ) .</li> <li>2. Dell Laser 1710.</li> <li>3. Properties ( ) →Installed Options ( ) μ</li> <li>4. →Ask Printer ( ) . OK→OK. Printers ( ) .</li> </ol>
Windows 2000 Windows NT 4.0	<ol style="list-style-type: none"> <li>1. Start ( ) →Settings ( μ ) →Printers ( )</li> <li>2. Dell Laser 1710.</li> <li>3. Properties ( ) →Installed Options ( μ ) ( Update Now ( μ ) ) . μ</li> <li>4. OK→OK. Printers ( ) .</li> </ol>
Windows Me Windows 98 SE	<ol style="list-style-type: none"> <li>1. Start ( ) →Settings ( μ ) →Printers ( )</li> <li>2. Dell Laser 1710.</li> <li>3. Properties ( ) →Device ( ) ( Features ( ) ) →Update ( μ ) ( Update Now ( μ ) ) .</li> <li>4. OK→OK. Printers ( ) .</li> </ol>

μ Update ( μ ) Ask Printer ( ) ,  
μ :

550 Available Options ( μ ) , 550-sheet tray ( ) .

Add ( ) .

OK, Printers ( ) .

μ Update Now ( μ ) Ask Printer ( ) ,  
μ :

Options ( ) 550 .

μ Not Installed ( μ ) Installed ( μ ) .

OK, Printers ( ) .

## Dell Laser 1710n

μ μ Configuration Web Tool ( Web μ 1710n μ Dell Printer

μ μ 1710n.

1. IP μ Web .



IP: , , μ

IP:

2. μ Printer Status ( ), Printer Settings ( μ )
3. Paper Menu ( ) Printer Settings ( μ ) .
4. PAPER SIZE ( ) .
5. μ .
6. Submit ( ) .
7. Printer Settings ( μ ) .
8. Paper Menu ( ) Printer Settings ( μ ) .
9. PAPER TYPE ( ) .
10. .
11. Submit ( ) .

μ

μ μ

128MB ( ) .

μ 160MB μ

μ 144MB μ μ .



: μ μ μ μ

1. μ μ μ μ .



2.

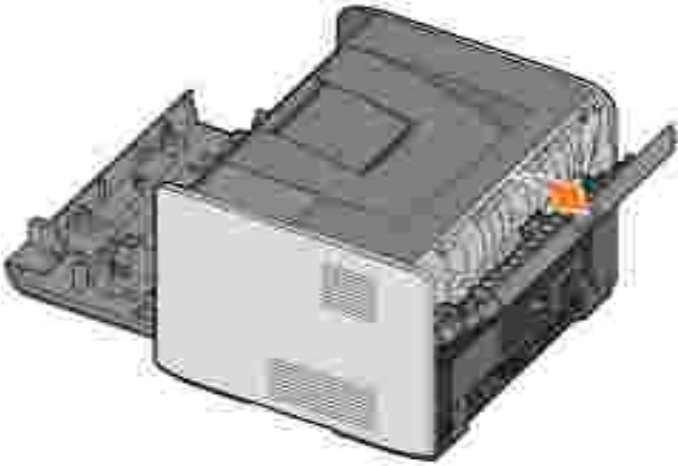

3.

⌘  
⌘

⌘

⌘

⌘

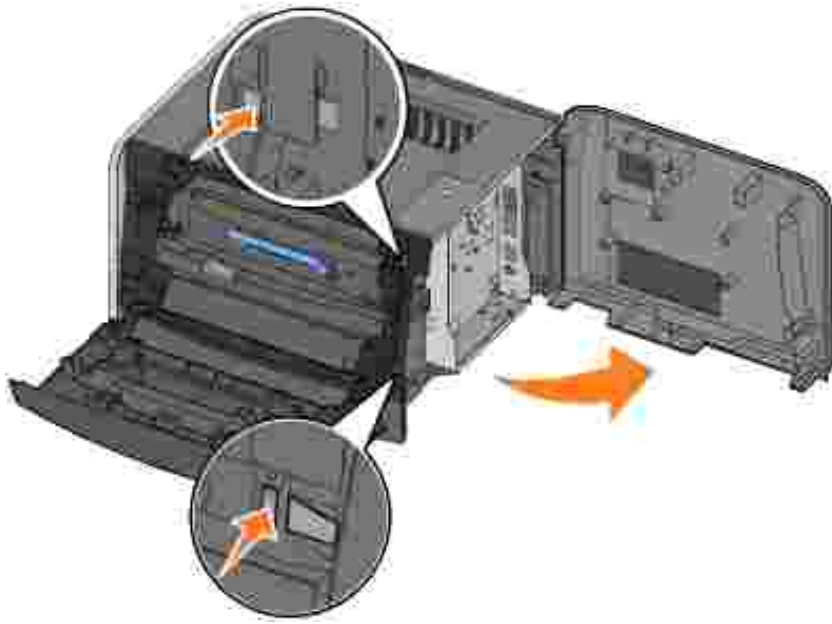

4.

|||



|||

:

|||

|||

|||

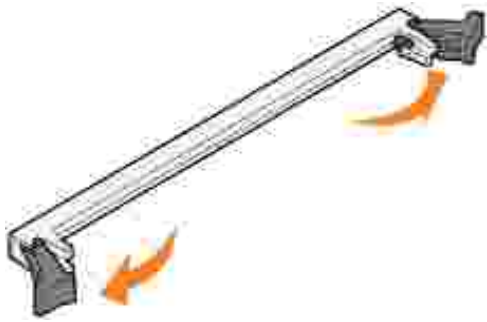

5.

|||



|||

:

|||

|||

|||

|||

:

|||

6.

|||

|||

|||

|||

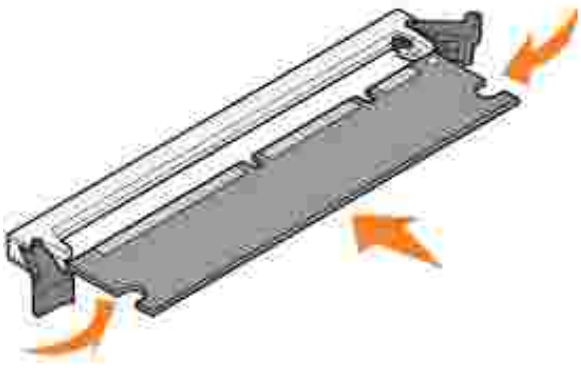

7.    μ μ    μ    μ
  
  - 8.
  9.    μ .
  - 10.
  11.    μ    μ .
  12.    μ    :
- Windows XP,    Start (    ) →Control Panel (    )→Printers  
and Other Hardware (    )    →Printers and Faxes (    )
- Start (    ) →Settings (    μ    )→Printers (    )  
Dell Laser 1710    μ    Properties (    )
- Install Options (    μ    )    μ μ  
Printer Memory (MB) (    μ    )
- OK.

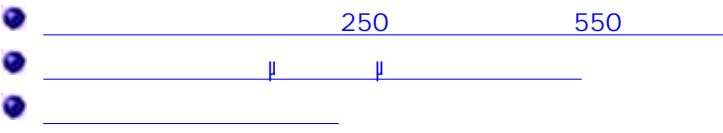

250

550

250

550

1.



2.



3.



4.

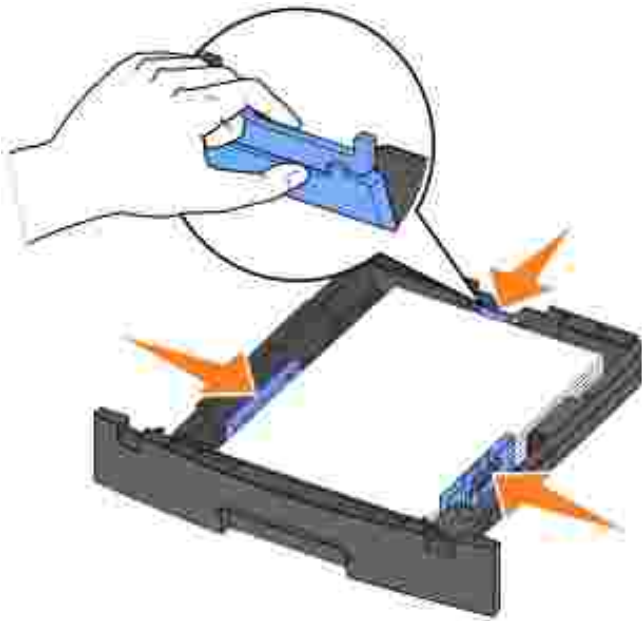

legal folio,

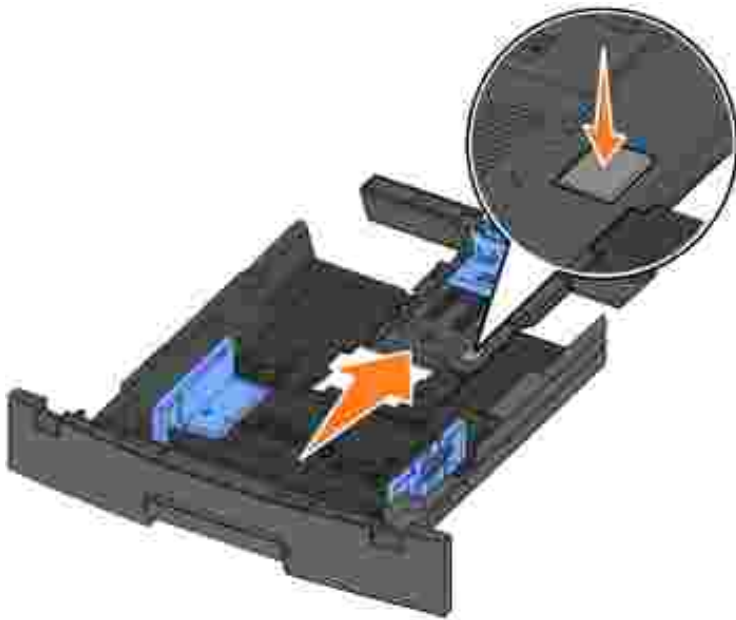

5.





6.



μ μ

μ

μ

μ

μ

μ

μ

μ

μ

μ

μ

μ

1.

μ

μ

μ

μ

:

μ

μ

μ

μ

μ

2.



3.



•

•

•

•

---

1. Connect the USB drive to the printer. The printer will automatically detect the drive and copy the files to the printer's memory. The files will be available for printing from the printer's control panel.



USB

Dell, *CD Drivers and Utilities*  
 Dell *CD Drivers and Utilities*  
 Dell *CD Drivers and Utilities*

Windows XP Professional x64 USB
Windows XP USB
Windows 2000 USB
Windows NT
Windows Me USB
Windows 98 SE USB
Macintosh OS 9.2 OS 10.2

Microsoft  
 Linux, *CD Drivers and Utilities*  
 unix\docs CD.

## Windows XP Professional x64

USB



Windows XP Professional x64

Wizard ( ) , Found New Hardware

1. CD Drivers and Utilities ( )

2. D:\Drivers\Print\x64\dkaayb40.inf Location ( ). D:\  
CD-ROM.

3. Next ( )

4. Finish ( )

5. CD Drivers and Utilities ( )

CD D Start ( ) →Run ( ) OK.  
D:\setup.exe ( D ) ( CD),

6. CD Drivers and Utilities ( )  
Personal Installation - Install the printer for use on this computer only  
( )

7. ( )

8. Typical Installation (recommended) [ ( ) ],  
Install ( )

( ) Congratulations

9. Print a Test Page ( )

10. Finish ( )

---

## Windows XP USB

 : Windows XP Professional

, Found New Hardware

- Wizard ( )
1. CD *Drivers and Utilities* ( )
  2. D:\Drivers\Print\Win\_2kXP\dkaay2da.inf Location ( ). D:\  
CD-ROM.
  3. Next ( )
  4. Finish ( )
  5. CD *Drivers and Utilities* ( )
  6. CD D:\setup.exe ( D Start ( ) →Run ( ) OK.  
Personal Installation - Install the printer for use on this computer only ( )
  - 7.
  8. Typical Installation (recommended) [ ( )],  
Install ( )  
Congratulations ( )
  9. Print a Test Page ( )
  10. Finish ( )

## Windows 2003 Server

## USB

- Wizard ( ) Found New Hardware
1. CD *Drivers and Utilities* ( )

2. D:\Drivers\Print\Win\_2kXP\dkaay2da.inf Location ( ). D:\  
CD-ROM.
3. Next ( ) .
4. Finish ( ) .
5. CD Drivers and Utilities ( )
6. D:\setup.exe ( D File Download ( ), Start ( ) →Run ( ), OK.  
Open ( ) .
7. CD Drivers and Utilities ( )  
Personal Installation - Install the printer for use on this computer only
8. Typical Installation (recommended) [ ( ) ],  
Install ( ) .
9. Print a Test Page ( )
10. Finish ( ) .

## Windows 2000

## USB

- Wizard ( ) Found New Hardware
1. CD Drivers and Utilities ( )  
Next ( ) .
  2. Search for a suitable driver ( )  
Next ( ) .

3. Specify a location only (  ),  Next  
(  ) .

4.   (  ) .

D:\Drivers\Print\Win\_2kXP\

D:\  CD-ROM (  ),  D:\  
 CD).

5.  Open (  ) ,  OK.

6.  Next (  )   .

D:\Drivers\Print\Win\_2kXP\dkaay2da.inf

7.  Finish (  )  .

8.   (  )   .

CD  Start (  ) →  Run (  )  
D:\setup.exe (  D  CD-ROM  CD ),  OK.

9.   (  )   .  
 Personal Installation - Install the printer for use on this computer only  
(  )   .

10.   .

11.  Typical Installation (recommended) [  (  ) ],  
 Install (  ) .

Congratulations  
(  ) .

12.  Print a Test Page (  )   .

13.  Finish (  )   .

---

## Windows NT



:

:

:



1. CD Drivers and Utilities ( # ).
2. # ) CD Drivers and Utilities ( # )  
Personal Installation - Install the printer for use on this computer only  
( )
3. # .
4. Typical Installation (recommended) [ ( # )],  
Install ( ).
5. Finish ( ) CD Drivers and Utilities ( # ).

Congratulations

## Windows Me #

## USB

 : # # # # #  
# USB # # # # #  
Hardware Wizard ( ) # # # # # Add New

1. CD Drivers and Utilities ( # )  
# USB, # # # # # USB CD  
# # # # # [# 3.](#)
2. # # # # # USB, Finish ( ).
3. Automatic search for the best driver (recommended) [ #  
# ( )], # # # # # Next ( # ) .
4. D:\Drivers\Print\Win\_9xme\  
( D # # # # # CD), # \ dkaay2da.inf  
OK.
5. # # # # # Next ( # ) # # # # # .

6. Next ( )
7. ( , Dell Laser Printer 1710) Next
8. Yes (recommended) [ ( )] Finish ( )
9. Yes ( )
10. Finish ( )
11. CD *Drivers and Utilities* ( )
- CD Start ( ) → Run ( ) OK.  
D:\setup.exe ( D )
12. CD *Drivers and Utilities* ( )  
Personal Installation - Install the printer for use on this computer only
- 13.
14. Typical Installation (recommended) [ ( )],  
Install ( )
- ( ) Congratulations
15. Finish ( ) CD *Drivers and Utilities* ( )

## Windows 98 SE

## USB

- 
- Found New Hardware Wizard ( )
1. CD *Drivers and Utilities* ( ) Next ( )

2. Search for a suitable driver (  ) ,  
 Next (  ) .
3.  USB,  CD-ROM drive (  CD-ROM ) // ,  
 Next (  ) .
- [8.](#)
4.  USB,  Next (  ) .
5.  USB,  Finish (  ).
- .
6.  Next (  )  .
7. Search for a suitable driver (  ) ,  
 Next (  ) .
8. Specify a location only (  ) ,  Next  
(  ) .
9.  *CD Drivers and Utilities* (  //  
// ) .
- D:\Drivers\Print\Win\_9xme\<  >\dkaay2da.inf
10.   to install the updated driver (recommended)  
[   (  )].
11.  Next (  ) .
12.  Next (  ) .
13.   (  , Dell Laser Printer 1710)  
  Next  
(  ) .
14.  Yes (  )   Finish (  ).
- .
15.  ,  Yes (  )  
  .
16.  Finish (  ) .
17. *CD Drivers and Utilities* (  //  )  
  .
- CD  Start (  ) →Run (  )  
D:\setup.exe (  D    CD),  OK.
18.  *CD Drivers and Utilities* (  //

19. Personal Installation - Install the printer for use on this computer only  
( )
20. Typical Installation (recommended) [ ( ) ],  
Install ( ).
- ( ). Congratulations
21. Finish ( ) CD Drivers and Utilities ( )  
( ).
- 

## Macintosh OS 9.2 OS 10.2

- Dell. Macintosh Web
1. support.dell.com, Small Business ( )
  2. Product Support ( ) , Downloads & Drivers  
( web )
  3. Product Model ( ) , Printer ( )  
1710n (Network Laser) (Laser )
  - 4.
  5. Select Your Download Category ( ) ,  
Printer Drivers ( )
  6. Select an Operating System ( ) ,  
Not Applicable ( )
  7. Select an Operating System Language ( ) ,  
( )
  8. Submit ( ) .
  9. Printer Drivers ( ) ,
  10. Driver ( ) ,
  - 11.
  12. Download Now Using HTTP ( HTTP) Download Now Using FTP  
( FTP) .

13. I agree (  ) .

14. Save to Disk (  ) , OK.

15. Save (  ) .

16.



17.  , Continue (  )

18.  .

- µ \_\_\_\_\_ ( µ \_\_\_\_\_ )
  - µ \_\_\_\_\_ ( µ \_\_\_\_\_ )
  - µ \_\_\_\_\_ USB \_\_\_\_\_ ( µ \_\_\_\_\_ )
  - µ \_\_\_\_\_
- 

µ µ µ ( µ )

µ \_\_\_\_\_ . µ \_\_\_\_\_

1. Ready/Data ( µ / µ )  µ , µ  
Continue (  µ µ µ µ )

2. Standard Network Card ( µ )  
Status ( µ ) µ Connected ( µ ) .

Status ( µ ) µ Not Connected ( µ ) :

- o Ethernet µ µ
- o Ethernet .

3. "TCP/IP" µ µ IP,

4. ping (command prompt) µ , ping µ ,  
IP ( µ , 192.168.0.11):

ping xxx.xxx.xxx.xxx

5. IP µ :

CD Drivers and Utilities ( µ )

/// )

CD Drivers and Utilities ( /// )  
| |

CD | Start ( ) → Run ( )  
D:\setup.exe ( D | | CD),  
OK.

/// | CD Drivers and Utilities ( /// )  
|, Set IP Address Utility ( | | )  
IP).

), "Configure Print Servers" ( | | )  
TCP/IP Settings ( | TCP/IP )  
OK.

Close ( | ).

## Windows XP

Windows XP, | | |  
| |  
Windows XP | |  
XP, | |

⊞ : Dell Windows XP |  
XP | Windows

1. Start ( ) → Help and Support ( ).
2. Search ( ),
3. Pick a Task ( | ) Enable or disable Internet Connection Firewall ( | Internet) ,

Windows XP, |

|

1. CD Drivers and Utilities ( /// )
2. CD Drivers and Utilities ( /// )

CD  
D:\setup.exe ( Start ( ) →Run ( )  
D OK,  
CD),

3. CD *Drivers and Utilities* ( //  
// ), Network Installation - Install the printer for use on a network  
( - .)

4. Install printer on this computer ( μ Next ( μ ) ) .

μ μ :  
Install printer on one or more remote computers ( μ μ ) , μ Next  
( μ ) .

( μ ) . μ Add

( μ ) . - μ μ Next

5. Update ( μ ) Add Printer ( )

6. I am setting up this printer on a server ( μ ) , μ Next ( μ ) .

7. μ Printer Name ( μ μ ) . ,

8. Share this printer  
with other computers ( μ μ ) ,

9. μ Next ( μ ) .

10. ( μ ) . μ μ , Install



11. μ Congratulations! ( μ ) ,  
μ Finish ( μ ) .

---

μ μ ( μ μ )

μ μ μ



1. Ready/Data ( / )    
 Continue (  )
2. Standard Network Card ( )   
 Status ( ) Connected ( ) .   
 Status ( ) Not Connected ( ) :   
 o Ethernet   
 o Ethernet
3. "TCP/IP" IP,
4. ping (command prompt) ping   
 IP ( , 192.168.0.11):   
 ping xxx.xxx.xxx.xxx
5. IP :   
 CD Drivers and Utilities (   
 CD Drivers and Utilities (   
 CD Start ( ) → Run ( )   
 D:\setup.exe ( D CD),   
 OK.   
 CD Drivers and Utilities (   
 Set IP Address Utility (   
 IP).   
 "Configure Print Servers" ( TCP/IP)   
 TCP/IP Settings ( TCP/IP)   
 OK.   
 Close ( ) .

µµ

-

1. CD Drivers and Utilities ( µµ )
2. CD Drivers and Utilities ( µµ )  
µ
3. CD Start ( ) →Run ( )  
D:\setup.exe ( D µµ µ CD), OK.
4. CD Drivers and Utilities ( µµ )  
( µµ ), Network Installation - Install the printer for use on a network ( )
5. Install printer on one or more remote computers ( µµ ) , µ Next  
( µ ) .
6. µ Add  
( ) .
7. µ Next ( µ ) .  
( µ ) . µ Next  
Add Printer ( µµ ) Update ( µµ )
8. µ Printer Name ( µµ ) .
9. µ Share this printer  
with other computers ( µµ ) ,
10. µ Next ( µµ ) .
11. µ µ , µ Install  
( µµ ) .
12. µ Congratulations! ( µµ !), µ µ
13. µ Finish ( )

µ USB

( µ µ µ )

USB



Dell Printer Configuration Web Tool ( Dell).  
USB Web



Microsoft

CD Drivers and Utilities ( )

Linux,

unix\docs CD.

<a href="#">Windows XP Professional x64 USB</a>
<a href="#">Windows XP USB</a>
<a href="#">Windows 2003 Server USB</a>
<a href="#">Windows 2000 USB</a>
<a href="#">Windows NT</a>
<a href="#">Windows Me USB</a>
<a href="#">Windows 98 SE USB</a>
<a href="#">Macintosh OS 9.2 OS 10.2</a>

Windows XP Professional x64

USB



Windows XP Professional x64

Wizard ( )

Found New Hardware

1. CD Drivers and Utilities ( )



2. D:\Drivers\Print\x64\dkaayb40.inf Location ( ). D:\  
CD-ROM.
3. Next ( ) .
4. Finish ( ) .
5. \_\_\_\_\_ .

## Windows XP USB



Windows XP Professional

Wizard ( ) Found New Hardware

1. CD *Drivers and Utilities* ( )
2. D:\Drivers\Print\Win\_2kXP\dkaay2da.inf Location ( ). D:\  
CD-ROM.
3. Next ( ) .
4. Finish ( ) .
5. \_\_\_\_\_ .

## Windows 2003 Server USB

Wizard ( ) Found New Hardware

1. CD *Drivers and Utilities* ( )
2. D:\Drivers\Print\Win\_2kXP\dkaay2da.inf Location ( ). D:\

CD-ROM.

3. Next ( ) .

4. Finish ( ) .

5. \_\_\_\_\_.

## Windows 2000 USB

Wizard ( ) , Found New Hardware

1. CD *Drivers and Utilities* ( ) ,  
Next ( ) .

2. Search for a suitable driver ( ) ,  
Next ( ) .

3. Specify a location only ( ) ,  
( ) . Next

4. *CD Drivers and Utilities* ( ) .

D:\Drivers\Print\Win\_2kXP\

D:\ CD-ROM ( ) , D:\  
D CD).

5. Open ( ) , OK.

6. Next ( ) .

D:\Drivers\Print\Win\_2kXP\dkaay2da.inf

7. Finish ( ) .

8. \_\_\_\_\_.

## Windows NT

\_\_\_\_\_

\_\_\_\_\_

## Windows Me

## USB

1. Hardware Wizard ( )  
USB, USB, USB, Add New  
CD *Drivers and Utilities* ( ).  
USB, USB CD  
[3.](#)
2. USB, Finish ( ).
3. Automatic search for the best driver (recommended) [ Next ( ) ].
4. `D:\Drivers\Print\Win_9xme\< >\ dkaay2da.inf`  
( D CD), OK.
5. Next ( )
6. Next ( )
7. ( , Dell Laser Printer 1710)  
Next  
( ) .
8. Yes (recommended) [ ( )] Finish ( )
9. Yes ( )
10. Finish ( )
11. [3.](#)

## Windows 98 SE

## USB

1. Hardware Wizard ( )  
USB, USB, USB, Add New  
CD *Drivers and Utilities* ( ).  
USB, USB CD  
[3.](#)
2. USB, Finish ( ).
3. Automatic search for the best driver (recommended) [ Next ( ) ].
4. `D:\Drivers\Print\Win_9xme\< >\ dkaay2da.inf`  
( D CD), OK.
5. Next ( )
6. Next ( )
7. ( , Dell Laser Printer 1710)  
Next  
( ) .
8. Yes (recommended) [ ( )] Finish ( )
9. Yes ( )
10. Finish ( )
11. [3.](#)

Wizard ( )

Found New Hardware

1. CD Drivers and Utilities ( )  
Next ( ) .

2. Search for a suitable driver ( )  
Next ( ) .

3. USB, CD-ROM drive ( CD-ROM) /  
Next ( ) .

8.

4. USB, Next ( ) .

5. USB, Finish ( ) .

6. Next ( ) .

7. Search for a suitable driver ( )  
Next ( ) .

8. Specify a location only ( )  
( ) . Next

9. CD Drivers and Utilities ( )  
( ) .

D:\Drivers\Print\Win\_9xme\<

>\dkaay2da.inf

10. [ ] to install the updated driver (recommended)  
( )].

11. Next ( ) .

12. Next ( ) .

13. ( , Dell Laser Printer 1710)  
( ) . Next

14. Yes ( ) Finish ( ) .

15. Yes ( )

16. Finish ( )

17. \_\_\_\_\_

## Macintosh OS 9.2      OS 10.2

- Dell.      Macintosh      Web
1. support.dell.com,      Small Business (
  2. Product Support (      ) ,      Downloads & Drivers
  3. Product Model (      ) ,      Printer (      )
  4. 1710n (Network Laser) (Laser      ).
  5. Select Your Download Category (      ),  
Printer Drivers (      ) .
  6. Select an Operating System (      ) ,  
Not Applicable (      ) .
  7. Select an Operating System Language (      ) ,
  8. Submit (      ) .
  9. Printer Drivers (      ) ,
  10. Driver (      ) ,
  - 11.
  12. Download Now Using HTTP (      HTTP)      Download Now Using FTP
  13. I agree (      ) .
  14. Save to Disk (      ) ,      OK.
  15. Save (      ) .
  - 16.
  17.      ,      Continue (      )
  18.      .



1. CD Drivers and Utilities ( // )
  2. CD Drivers and Utilities ( // )  
 |  
 |  
 | CD Start ( ) → Run ( )  
 D:\setup.exe ( D | CD), OK.  
 Windows 2003 Server, Open ( | ) File Download ( ).
  3. | CD Drivers and Utilities ( //  
 // ), Network Installation - Install the printer for use on a network  
 ( - )
  4. | Install printer on this computer ( | Next ( | ) ).  
 | :  
 | Install printer on one or more remote computers ( | Next  
 ( | ) .  
 | Add  
 ( | ) .  
 | - | Next  
 ( | ) .
  5. | Update ( | ) Add Printer ( )
  6. | I am setting up this printer on a server ( | Next ( | ) ) .
  7. | Printer Name ( | ) .
  8. | Share this printer  
 with other computers ( | ) ,
  9. | Next ( | ) .
  10. | Install  
 ( | ) .
  11. | Congratulations! ( | ) ,  
 | Finish ( | ) .
-

Point and Print USB Microsoft  
 Dell, Status Monitor ( Microsoft, CD Drivers and Utilities ( # ).

1. Windows XP: Start ( ) →Control Panel ( )→Printers and Other Hardware ( ) →Printers and Faxes ( ) .
2. Dell Laser 1710.
3. File ( )→Sharing ( ) .
4. If you understand the security risk but want to share printers without running the wizard, click here ( ) .
5. Just enable printer sharing ( ) , OK.
6. Share this printer ( ) , Shared Name ( ) .
7. Additional Drivers ( ) ,
8. OK.

- Printers ( ) Windows 2000, ( )
- My Network Places ( ) Network Neighborhood ( ) .
- point and print ( ) ( ) ( )



1. Windows XP: Start ( ) →Control Panel ( )→Printers and Other Hardware ( ) →Printers and Faxes ( ).

2. Start ( ) →Settings ( )→Printers ( ) Add Printer ( ) Add Printer wizard ( ).

3. Network Print Server ( ) .

4. Shared printers ( ).

5. OK.

6. Finish ( ).

7. .

Windows XP: Start ( ) →Control Panel ( )→Printers and Other Hardware ( ) →Printers and Faxes ( ).

: Start ( ) →Settings ( )→Printers ( )

File ( )→Properties ( .)

General ( ), Print Test Page ( )

.



- [Dell\(TM\) Toner Management System \( Dell\(TM\)\)](#)
- [Dell Local Printer Settings Utility \( Dell\)](#)
- [Set IP Address Utility \( IP\)](#)
- [Dell Printer Software Uninstall \( Dell\)](#)
- [Driver Profiler \( \)](#)
- [Dell Printer Configuration Web Tool \( Web Dell\)](#)

CD Drivers and Utilities ( )

 : CD Drivers and Utilities ( )

 : Linux Macintosh.

---

## Dell? Toner Management System ( Dell?)

### Status Monitor Center ( )

 : Windows 98 SE Me,

Status Monitor Center ( )

- Run ( ) Status Monitor ( Status Monitor ( )
- View ( )
- Help ( )

### Printing Status Window ( )

 : Windows NT, 98 SE, Me,

Printing Status ( ) (Printer Ready)

( ), Printer Offline ( ), Error-Check Printer ( )  
 Printing Status ( )  
 •  
 • Order Toner ( )  
[Dell Printer Supplies Reorder Application \( Dell\)](#)

## Dell Printer Supplies Reorder Application ( Dell)

 : Windows 98 SE Me.  
 Status ( Order Supplies ( ), Programs ( ) ) Printing  
 Web.  
 1. Start ( ) → Programs ( ) All Programs ( Dell Laser 1710) → Dell Printers ( Dell) → Dell Laser Printer 1710 ( Dell Laser 1710) → Printer Supplies Reorder Application ( )  
 Order Supplies ( ).  
 2. Web, Visit Dell's cartridge ordering web site ( web Dell ).  
 3. Telephone ( ). By

## Dell Local Printer Settings Utility ( Dell)

 :  
 Dell) Dell Local Printer Settings Utility ( Alarm Control ( )  
 ( , )  
 ( )  
 ( )

Dell Local Printer Setup Utility ( ) → Programs ( ) → All Programs ( ) → Dell) → Dell Laser Printer 1710 ( ) → Dell Laser 1710) → Dell Local Printer Settings Utility ( ) → Dell) . Dell Local Printer Settings Utility ( )

( ) Dell) : Dell Local Printer Settings Utility

Finishing Settings ( ) Duplex ( ) Duplex Bind ( ) Copies ( ) Blank Pages ( ) Collation ( ) Separator Sheets ( ) Separator Source ( ) Multipage Print ( ) Multipage Order ( ) Multipage View ( ) Multipage Border ( )	Paper Settings ( ) Paper Source ( ) Paper Size ( ) <sup>1</sup> Paper Type ( ) <sup>1</sup> Custom Types ( ) <sup>2</sup> Substitute Size ( ) Configure MP ( ) Paper Texture ( ) <sup>3</sup> Paper Weight ( ) <sup>3</sup> Paper Loading ( ) <sup>3</sup>	Parallel Settings ( ) PCL SmartSwitch PS SmartSwitch Parallel Buffer ( ) Advanced Status ( ) Honor Init ( )	PCL Emulation Settings ( ) PCL) Orientation ( ) Lines Per Page ( ) A4 Width ( 4) Tray Renumber ( ) <sup>1</sup> Auto CR after LF ( ) Auto LF after CR ( )
PostScript Settings ( ) PostScript)	Quality Settings ( )	Setup Settings ( )	USB Settings ( ) USB)

Print PS Error ( )	Print Resolution ( )	Printer Language ( )	PCL SmartSwitch
Font Priority ( )	Toner Darkness ( )	Power Saver ( )	PS SmartSwitch
	PQET	Resource Save ( )	USB Buffer ( )
	PictureGrade	Download Target ( )	
		Print Timeout ( )	
		Wait Timeout ( )	
		Auto Continue ( )	
		Jam Recovery ( )	
		Page Protect ( )	
		Print Area ( )	
		Display Language ( )	
		Alarm Control ( )	
		Toner Alarm ( )	
1			
2			
3			

## Set IP Address Utility (IP)

µµ µ



Set IP Address Utility ( µµ µ IP) µ



1. Dell Printer Configuration Web Tool ( Dell) Web IP
  2. Printer Settings ( )
  3. Printer Server Settings ( ), TCP/IP.
  4. IP Address ( ) Netmask  
( ) Gateway ( ) .
- 
5. Submit ( ) .
  6. Dell Printer Configuration Web Tool ( Dell) Web IP
- 

## Dell Printer Software Uninstall ( Dell)

- Uninstall Software Utility ( )
- Uninstall Software Utility ( ) :
- Windows XP: Start ( ) →Control Panel ( )→Printers and Other Hardware ( ) →Printers and Faxes ( ) .
- : Start ( ) →Settings ( ) →Printers ( )
- Dell Software Uninstall ( Dell) .
- Next ( ) .
- Uninstall Now ( ) .
- OK
- Start ( ) →Programs ( ) All Programs ( Dell) →Dell Printers ( Dell) →Dell Laser Printer 1710 ( Dell Laser 1710) .
- Dell Printer Software Uninstall ( )

Dell).

Next ( ) .

Uninstall Now ( ) .

OK

---

## Driver Profiler ( )

Driver Profiler ( )

- N ( )
- ( )
- ( )
- 
- 
- 
- 

---

## Dell Printer Configuration Web Tool ( Dell) Web



Dell Printer Configuration Web Tool ( Dell) Web

Dell Printer Configuration Web Email Alert Setup ( )

Dell) Dell Printer Configuration Web Tool ( Web

IP



Dell Printer Configuration Web Tool ( Dell) Web

Web. Dell), Dell Printer Configuration Web Tool ( IP Web Web.

IP. IP. Continue (  Set IP Address Utility ( IP).

Dell) Dell Printer Configuration Web Tool ( Web

Printer Status ( )

Printer Settings ( )

## Copy Printer Settings ( )

IP  
: .

## Printing Statistics ( )

.

## Printer Information ( )

, .

## Email Alert Setup ( )

.

## Set Password ( )

.

## Online Help ( )





































Help ( ) web Dell



μ ( , μ μ , / μ , μ )

μ μ μ μ

Continue ( )	Ready/Data ( μ / μ )	Toner Low/Replace Drum ( μ )/ μ )	Load/ Remove Paper ( ) /	Paper Jam ( μ )	Error ( )

*					

Error ( ) ! Continue ( )

Continue ( )

Continue (  )	Ready (  ) / Data (  )	Toner Low (  ) / Replace Drum (  )	Load/Remove Paper (  )	Paper Jam (  )	Error (  )	

						μ μ
						μ μ

μ μ						
Continue (  )	Ready/Data (  /  )	Toner Low (  )/ Replace Drum (  )	Load Paper (  )	Paper Jam (  )	Error (  )	
						μ *
						μ μ μ
						μ
						μ μ
						μ 1



\*

Continue  
 Cancel  
 Ready | On  
 Toner Low  
 Flaming (Fused) State  
 Local (Remote) Paper  
 Power Jack  
 Home

•

•

• Continue ( )

• Cancel ( )

• Power Saver ( )

( Dell Local Printer Settings Utility ( Dell ) ).

Continue  
 Cancel  
 Ready | On  
 Toner Low  
 Flaming (Fused) State  
 Local (Remote) Paper  
 Power Jack  
 Home

•

• flash

• flash.

• flash.

•

• Cancel ( )

• Cancel ( )

• flash, flash,

• flash:

- ( ) Busy
- Ready ( )
- Cancel ( )
- Cancel ( )
- /
- 
- Cancel ( )
- Cancel ( )

Continue

Cancel

Ready (Data)

Time-Lock

Printing (Push/Pull) Status

Lock (Electronic Paper)

Power Lock

Home

- 
- Cancel ( )

Continue

Cancel

Ready (Data)

Zoom In



Zooming (Page Size)

Lock (Electronic Paper)

Power Lock

Home

μ :  
μ μ  
μ μ

μ :  
• Continue (  )  
• Cancel (  )  
• Cancel (  )

Continue

Cancel

Ready (Data)

Zoom In



Zooming (Page Size)

Lock (Electronic Paper)

Power Lock

Home



μ :  
• μ μ μ μ  
• 600 (dpi) 300 dpi μ μ

μ :  
• ( μ μ ) μ Ready  
• Cancel (  )  
• Cancel (  )

 Continue  
 Cancel  
 Ready | Data  
 Zoom | Low  
 Reading | Flipback | Close  
 Lock | Electronic Paper  
 Power | Lock  
 Home

μ : μ μ

μ :

- μ Continue (  Ready ( μ ) Busy ( μ ) ).
- μ Cancel (  )
- μ μ Cancel (  )

 Continue  
 Cancel  
 Ready | Data  
 Zoom | Low  
 Reading | Flipback | Close  
 Lock | Electronic Paper  
 Power | Lock  
 Home

μ :

μ :

Continue  
 Cancel

Ready To Print  
 Zoom Low  
 Reading Progress On  
 Lock Electronic Paper  
 Power Lock  
 Home

:

---

:  
 1 550  
 Continue (  )  
 550 1  
 Cancel (  )

Continue  
 Cancel

Ready To Print  
 Zoom Low  
 Reading Progress On  
 Lock Electronic Paper  
 Power Lock  
 Home

:

---

:  
 ,  
 Continue (  )  
 Cancel (  )

Continue

Cancel

Ready | Done

Zoom Out

Flipping Flipbook Over

Lock | Electronic Paper

Power Lock

Home

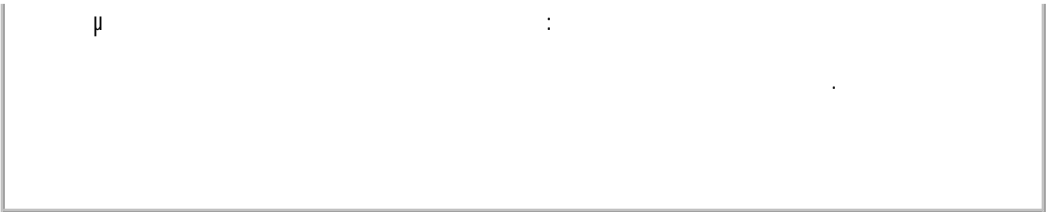

Continue (  )

Cancel (  )

Continue

Cancel

Ready | Done

Zoom Out

Flipping Flipbook Over

Lock | Electronic Paper

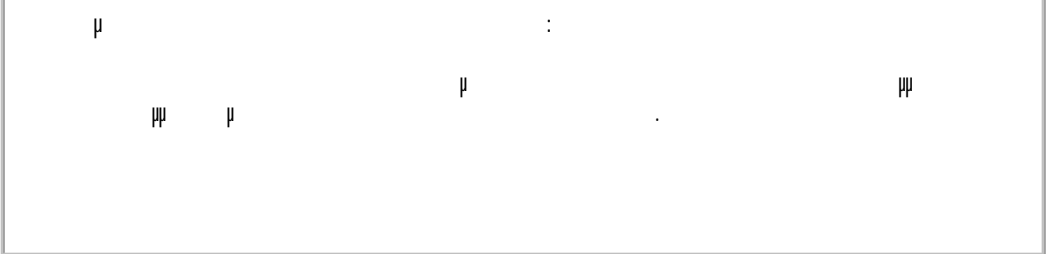

Power Lock

Home



Continue (  )

 Continue  
 Cancel  
 Ready (Data)  
 Toner Low  
 Reaching Page/Line Count  
 Load (Remove Paper)  
 Paper Jam  
 Error

• Continue (  )  
 • ( )  
 • Cancel (  )

 Continue  
 Cancel  
 Ready (Data)  
 Toner Low  
 Reaching Page/Line Count  
 Load (Remove Paper)  
 Paper Jam  
 Error

• Toner Alarm ( )  
 • Setup Settings ( )  
 • Continue (  )  
 • ( )





 Continue  
 Cancel  
 Ready 1-Click  
 Zoom-Lens  
 Reading Flipbook Glass  
 Lock Electronic Paper  
 Power Lock  
 Home

$\mu$  :  $\mu$

$\mu$  :  $\mu$

$\bullet$   
 $\bullet$

$\mu$  (  $\mu$  )

 Continue  
 Cancel  
 Ready 1-Click  
 Zoom-Lens  
 Reading Flipbook Glass  
 Lock Electronic Paper  
 Power Lock  
 Home

$\mu$  :  $\mu$

$\mu$

$\mu$  :  $\mu$

$\mu$  (  $\mu$  )







Printer status: Ready (1 Color)

support.dell.com Dell





- Printer status: Ready (1 Color)
- flash.
- 300 dpi.

- Continue (  )
- Continue (  )





 Continue  
 Cancel  
 Ready To Print  
 Troubleshoot  
 Printing Properties  
 Load Ethernet Paper  
 Power Lock  
 Help

The printer is ready to print.

- Click **Continue** (  ) to continue.
- Click **Continue** (  ) to continue.

 Continue  
 Cancel  
 Ready To Print  
 Troubleshoot  
 Printing Properties  
 Load Ethernet Paper  
 Power Lock  
 Help

The printer is ready to print.



- Click **Continue** (  ) to continue.
- (  )
  - **Page Protect** (  ) **On**
  - **Setup Settings** (  )
  - **Local Printer Settings Utility** (  )

Control panel with buttons: Continue (green play), Cancel (red X), Ready to Date, Zoom In, Zoom Out, Reading Page Bar, Lock Electronic Paper, Paper Lock, and Home.

$\mu$

$\mu$   $\mu$   $\mu$   $\mu$   $\mu$   $\mu$  :

$\mu$  :

- $\mu$   $\mu$   $\mu$  (  $\mu$   $\mu$  ) .
- $\mu$  Continue (  )
- $\mu$  Cancel (  )

Control panel with buttons: Continue (green play), Cancel (red X), Ready to Date, Zoom In, Zoom Out, Reading Page Bar, Lock Electronic Paper, Paper Lock, and Home.



$\mu$

$\mu$   $\mu$  :

$\mu$   $\mu$   $\mu$  :

- $\mu$   $\mu$
- $\mu$
- $\mu$   $\mu$   $\mu$

$\mu$  :

- $\mu$  Continue (  )
- $\mu$   $\mu$  (  $\mu$   $\mu$  )
- $\mu$  Cancel (  )
- $\mu$   $\mu$  Cancel (  )
- $\mu$   $\mu$  :
- $\mu$   $\mu$   $\mu$  :
- $\mu$   $\mu$   $\mu$  (  $\mu$   $\mu$  ) .



 Continue  
 Cancel  
 Ready | Data  
 Power On  
 Flashing Red/Blue Chime  
 Local Ethernet Power  
 Power Jack  
 BIOS

(  adapter ). ENA (external network

•  Cancel (  )

 Continue  
 Cancel  
 Ready | Data  
 Power On  
 Flashing Red/Blue Chime  
 Local Ethernet Power  
 Power Jack  
 BIOS

USB

Continue (  )  
 USB Disabled (  )  
 USB Buffer (  USB) Parallel Buffer (  )  
 Dell Local Printer Settings Utility (  Dell ).

Continue

Cancel

Ready to Print

Zoom In

Zoom Out



Flip to Previous Page

Flip to Next Page

Home

µ  
µ :

µ :

- µ Continue (  ) ( µ )
- µ Cancel (  )
- µ Cancel (  )
- ○
- µ ( µ µ )

Continue

Cancel

Ready to Print

Zoom In

Zoom Out



Flip to Previous Page

Flip to Next Page

Home

µ  
µ :

µ :

- µ
- µ µ µ , µ ( µ )
- µ Continue (  ) µ µ
- µ Cancel (  )



 Continue  
 Cancel  
 Ready 1-Click  
 Zoom-Lens  
 Reading Playback Glass  
 Lock Electronic Paper  
 Power Lock  
 Home

$\mu$   
 $\mu$  :  
 $\mu$   $\mu$   $\mu$   $\mu$   $\mu$

$\mu$  :  
 $\mu$   $\mu$   $\mu$

 Continue  
 Cancel  
 Ready 1-Click  
 Zoom-Lens  
 Reading Playback Glass  
 Lock Electronic Paper  
 Power Lock  
 Home

$\mu$   
 $\mu$  :  
 $\mu$   $\mu$   $\mu$   $\mu$   $\mu$

$\mu$  :  
 $\mu$

μ

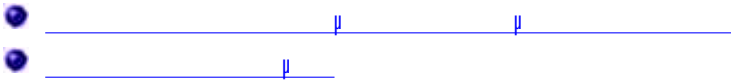

μ

μ



1.

2.

3.

4.





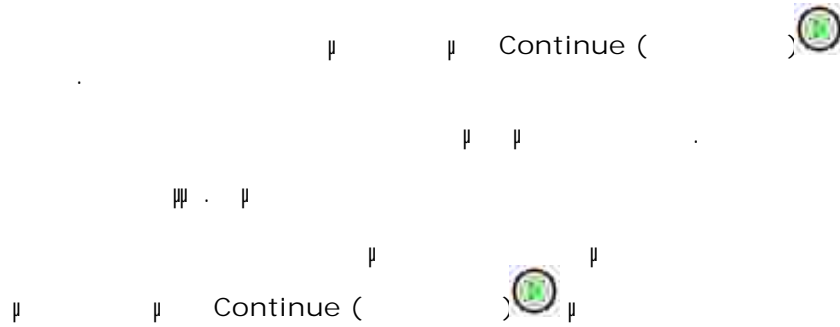

5.





6.



: μ μ μ

μ

μ Ready ( μ )  , Toner Low ( μ  
 μ )  /Replace Drum ( μ )  Load/Remove Paper  
 ( μ /  ) , Paper Jam ( μ  ) μ  
 μ Error ( μ )  Continue ( μ )  

- Cancel ( ) 
- Continue ( ) 
- Continue ( ) 
- Cancel ( ) 
- 

( <x>).

### NPA

- o
- o ( )

### PostScript Macintosh

- o — PostScript
- o — PostScript
- o ( ) — Windows

µ Macintosh.

µ

µ

µ :

µ

µ

µ

µ

µ :

o µ ( µ µ ) —

o 10Mbps, Half Duplex—  
10Mbps, Half Duplex ( µ µ µ ). µ µ

o 10Mbps, Full Duplex—  
10Mbps, Full Duplex ( µ µ µ ). µ µ

o 100Mbps, Half Duplex—  
µ 100Mbps, Half Duplex ( µ µ µ ). µ

o 100Mbps, Full Duplex—  
µ 100Mbps, Full Duplex ( µ µ µ ). µ

µ

µ

µ

µ

## NPA

µ

µ :

µ

µ :

o

o

o µ ( µ µ )

µ

µ :

µ

µ

µ



μ μ )

μ μ μ : μ . μ

μ :

- ( μ μ )
- 

Auto LF after CR ( μ μ μ )

μ μ μ μ μ : μ

μ :

- ( μ μ μ )
- 

## USB

μ μ USB μ μ μ  
Universal Serial Bus (USB).

## NPA

μ μ μ μ : μ  
μ μ μ μ :  
○  
○  
○ μ ( μ μ )

PostScript Macintosh

PostScript Macintosh.

:

PostScript

PostScript

Windows Macintosh.

Windows  
Macintosh. Windows

μ

μ

:

•

•

USB.

(RAM)

( μ flash ) μ μ

μ μ

μ μ μ //

μ μ μ μ μ μ μ

μ ρ ρ ρ ρ ρ

μ :  
○ ( μ μ )  
○

μ

μ μ ρ : μ ρ ρ ρ ρ

- μ μ ρ ρ ρ ρ ρ
- μ ρ ρ ρ



- \_\_\_\_\_
- \_\_\_\_\_ ( \_\_\_\_\_ )
- \_\_\_\_\_ ( N \_\_\_\_\_ )
- \_\_\_\_\_
- \_\_\_\_\_
- \_\_\_\_\_
- \_\_\_\_\_

\_\_\_\_\_

\_\_\_\_\_



1. \_\_\_\_\_ File ( \_\_\_\_\_ ) → Print ( \_\_\_\_\_ ) .
2. \_\_\_\_\_ Properties ( \_\_\_\_\_ ) , \_\_\_\_\_ Options ( \_\_\_\_\_ ) Printer ( \_\_\_\_\_ ) Setup ( \_\_\_\_\_ )

3. Paper ( )

4. Manual paper ( ) Paper tray ( )

5.

6. OK.

7. OK Print ( )

8.

○

○

○

○

9.

10.



μ μ μ μ μ " " μ μ

μ ) (

μ μ μ 1 μ 550 μ 1

) Short Edge ( ) : Long Edge (

- Long Edge ( ) μ μ μ μ , μ μ μ μ ) .

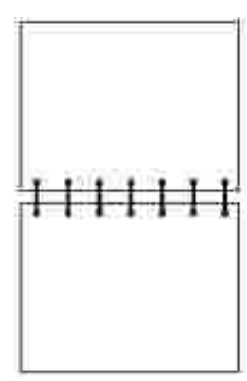
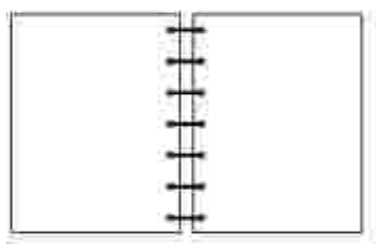

- Short Edge ( ) μ μ μ μ , μ μ μ μ ) .

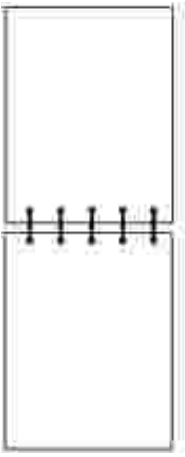

1. File ( ) → Print ( ).
2. Properties ( ) , Options ( ) Printer ( ) Setup ( )
3. Page Layout ( ), 2-sided printing ( ) .
4. Long Edge ( ) Short Edge ( ) .
5. Manual 2-sided printing ( ) .
6. Paper ( )
7. Input options ( )
8. OK.
9. OK Print ( ) .

10. Load Paper ( )  , Continue

( N )

Multipage Printing (N-up) ( ), 2-up (2 ), 4-up (4 )

Multipage Order ( ), Multipage View ( ), Multipage Border ( )

1. File ( ) → Print ( ).
2. Properties ( ) Options ( ) Printer ( ) Setup ( )
3. Page Layout ( ), ( )

Multipage Order ( ) 4-Up (4 )  
Across ( )

1	2
3	4

Down ( )

1	3
2	4

4. Print page borders

( )

5. OK.

6. OK Print ( )

Booklet ( )

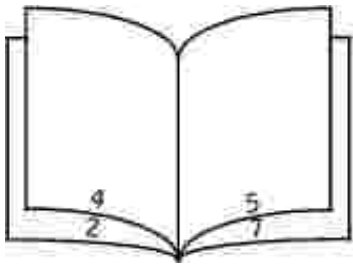

Sheets per Bundle

Print Using Booklet

File ( ) → Print ( ) .

Properties ( ) Options ( ) Printer ( ) Setup ( )

Page Layout ( ) More Page Layout Options ( )

Booklet ( )

Sheets per Bundle

Print fold mark ( )

8. OK

9. OK Print ( )

---

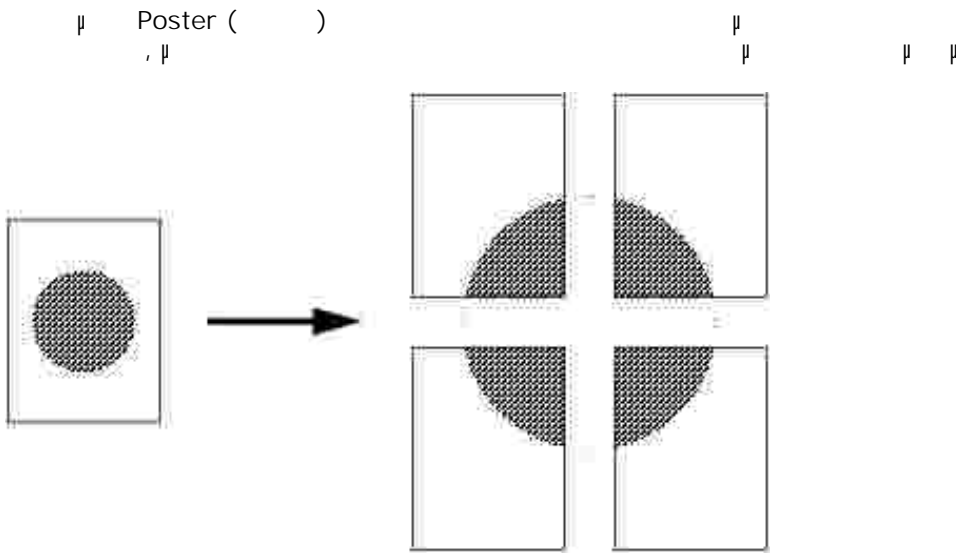

1. File ( ) → Print ( ).

2. Properties ( ) , Options ( ) , Printer ( ) , Setup ( )

3. Page Layout ( ) , More Page Layout Options ( )

4. Poster ( ).

5. ,

6. Print crop marks ( )

7.

8. OK

9. OK Print ( )

---

1.

o Tray 1 or 2 ( 1 2) —

o Manual feeder ( ) —



\_\_\_\_\_ ).

2.

File ( ) → Print ( ).

3.

Properties ( ) Options ( ) Printer ( ) Setup ( )

4.

Paper ( )

5.

Letterhead ( ) Paper type ( ).

6.

7.

OK.

8.





OK Print ( )



μ μ





|| Cancel (  ) .

1. Windows XP: Start (  ) →Control Panel (  )→Printers and Other Hardware (  )→Printers and Faxes (  ) .

: Start (  ) →Settings (  )→Printers (  )

2.  .

|| || || .

3. Cancel (  ) .

- \_\_\_\_\_
  - \_\_\_\_\_
  - \_\_\_\_\_
  - \_\_\_\_\_
  - \_\_\_\_\_
  - \_\_\_\_\_
- 

μ

1. Start ( ) → Programs ( ) All Programs ( )  
→ Dell Printers ( ) → Dell Laser Printer 1710 ( )  
→ Dell Printer Supplies → Laser ( )  
(-Laser).
  2. Order Toner Cartridges ( ):  
Dell  
Visit Dell's cartridge ordering website ( )  
Dell
  3. Web [www.dell.com/supplies](http://www.dell.com/supplies).
- 

μ

μ

- 21°C (70°F) 40%.

- 
- 
- 

40°C (104°F).

- 
- 
- 
- 
- 
- 
- 



Toner Low ( )



Toner low ( )

- 1.





2.

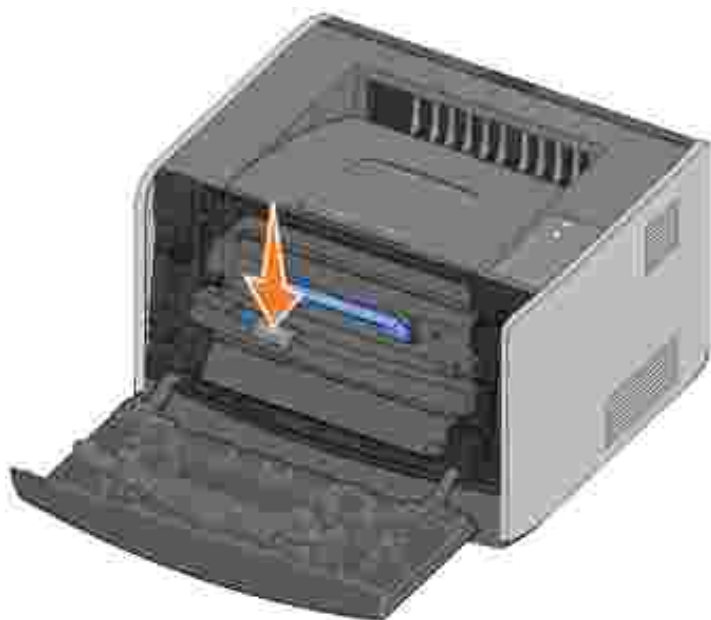

3.



4.

5.

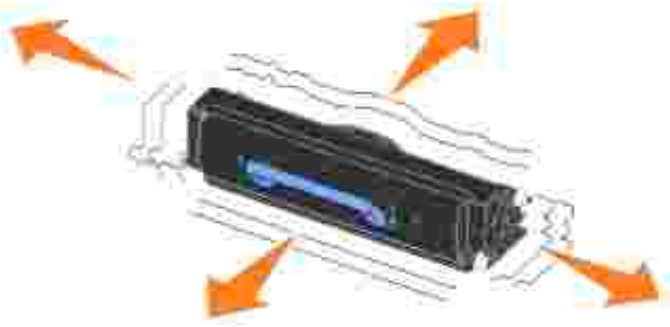

6.



7.

μ

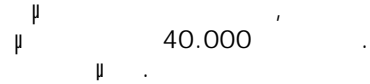

40.000

Replace imaging drum (

( 30.000 ),

40.000



1.



2.



3.





4.



5.

6.



7.

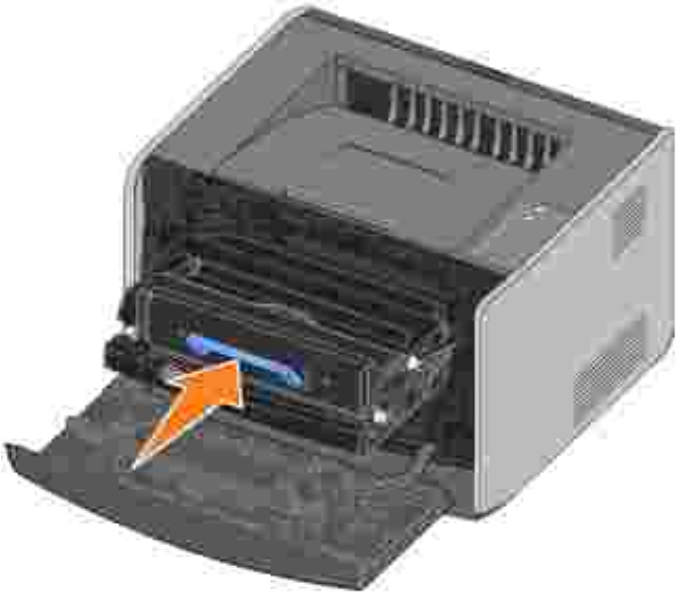

8. Press the **Cancel** button.

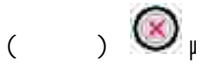

9. Press the **Next** button.

---

**μ**

1. Press the **μ** button.

2. Press the **μ** button.



3.





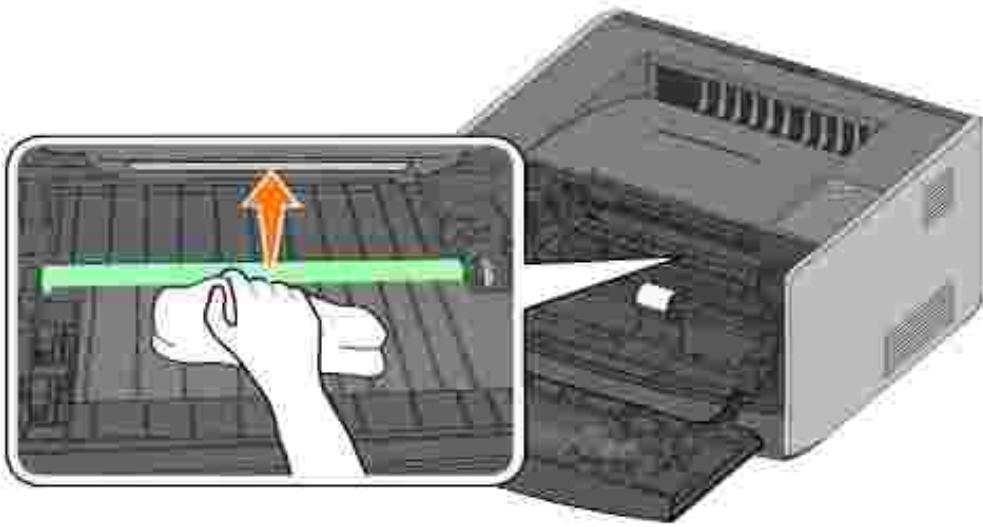













4.





5.     



6.           



7.  

8. 

---

CD Drivers and Utilities ( μμ ) μ CD μμ  
μμ Uninstall Software Utility ( μμ ) μμ .

μ Uninstall Software Utility ( μμ ) μμ .

- Windows XP: Start ( μ ) →Control Panel ( μμ ) →Printers and Other Hardware ( μμ ) →Printers and Faxes ( μμ ) .

μ Start ( μ ) →Settings ( μμ ) →Printers ( μμ ) .

μ Dell Software Uninstall ( μμ Dell) .

μ Next ( μμ ) .

μ Uninstall Now ( μμ ) .

μ OK .

- Start ( μ ) →Programs ( μμ ) All Programs ( μμ ) →Dell Printers ( μμ Dell) →Dell Laser Printer 1710 ( μμ Dell Laser 1710) →Dell Printer Software Uninstall ( μμ Dell) .

μ Next ( μμ ) .

μ Uninstall Now ( μμ ) .

μ OK .

μ

μ

- \_\_\_\_\_ μ
- \_\_\_\_\_ μ
- \_\_\_\_\_ μ

μ

μ













μ μ

μ ,  
μ

μ

Dell

support.dell.com.

 /Replace Drum ( 	<p>Toner Low ( μ μ )</p>  
<p>Toner Low ( μ μ )</p>  	<p>/Replace Drum ( μ )</p> 
<p>Toner Low ( μ μ )</p>  	<p>/Replace Drum ( μ )</p> 
<p>Toner Low ( μ μ )</p>  	<p>Error ( μ ) !</p> 

Load Paper ( 250 )

550



⌘

Error ( ⌘ ) !

⌘

⌘

•

⌘

⌘

•

⌘

⌘

⌘

•

•

⌘

⌘

⌘

⌘

•

•

⌘

USB

⌘

•

⌘

⌘

Continue (

)

⌘

⌘

•

⌘

⌘

⌘

⌘

⌘

⌘

⌘

•

⌘

support.dell.com.

⌘

⌘

⌘

⌘

Dell

⌘

⌘

⌘

⌘

⌘

Dell

support.dell.com.

⌘

Paper Jam

( ⌘

)



Continue (

)

⌘

Continue (

)

⌘

⌘

⌘

⌘

⌘

:

1.

⌘

⌘

⌘

⌘



2.



3.





4.

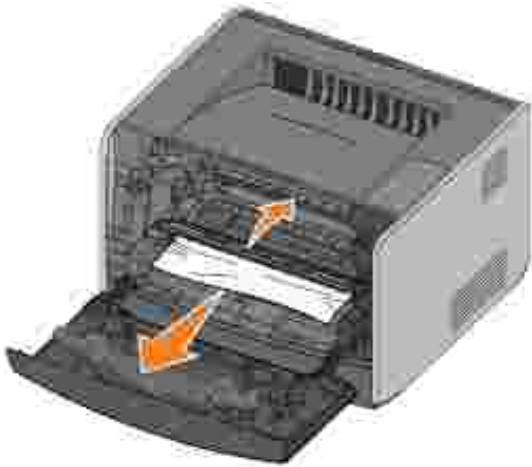

5.



6.

Continue (



μ

μ

μ μ

μ ,  
μ

μ

μ  
Dell

μ  
support.dell.com.

μ .

- $\mu$  Toner Darkness ( )<sup>2</sup>
- $\mu$
- $\mu$
- $\mu$
- $\mu$

$\mu$  :

- $\mu$  Toner Darkness ( )<sup>2</sup>  $\mu$
- $\mu$
- $\mu$
- $\mu$
- $\mu$

---

$\mu$

- $\mu$  Toner Darkness ( )<sup>2</sup>
- $\mu$

$\mu$  :

- $\mu$  Toner Darkness ( )<sup>2</sup>  $\mu$
- $\mu$

---

$\mu$   $\mu$

$\mu$  :

- $\mu$
- $\mu$
- $\mu$

---

$\mu$

(  $\mu$   $\mu$   $\mu$  )  $\mu$  1

---

$\mu$

$\mu$  :

- $\mu$   $\mu$   $\mu$   $\mu$   $\mu$
- $\mu$

---

$\mu$

- $\mu$
- $\mu$



- Form Type ( )
- \_\_\_\_\_

Form Size ( )

Form Size ( )

( )

- \_\_\_\_\_
- \_\_\_\_\_
- \_\_\_\_\_

\_\_\_\_\_

\_\_\_\_\_

- \_\_\_\_\_
- \_\_\_\_\_

\_\_\_\_\_

Paper Texture ( )  
 Paper Texture ( )  
 Rough ( ) Normal ( ) Smooth ( )

μ

- ρ ρ ρ ρ ;
- ρ ρ ρ ρ ρ ρ ;
- ρ ρ ρ ρ ;
- ρ ρ ρ ρ ρ ρ ;
- ρ ρ ;
- ρ ρ ρ ρ ;
- ρ ;
- ρ ρ ρ ρ ;
- ρ ρ ρ ρ ρ ;
- ρ ρ ρ ρ ρ ρ ;

Continue (  )

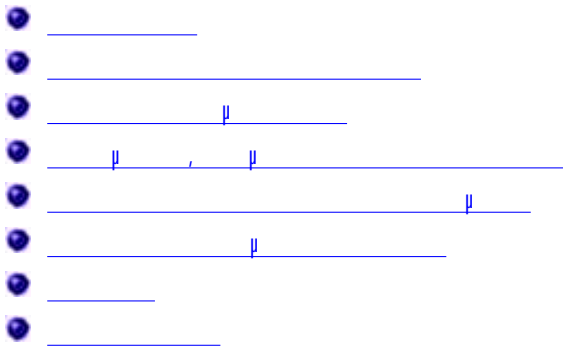

	1710	1710n
μ μ	16MB	32MB
μ μ	144MB	160MB
	USB	USB 10/100BaseTx Ethernet
μ μ 5%	3.000	3.000
(μ )	500 /μ	500 /μ
(μ )	10.000 /μ	10.000 /μ
	120.000	120.000

	μ	μ ) (	μ
	16 32°C (60 90°F)	8 80%	0 2500M (8.200 )
	0 40°C (32 104°F)	8 80%	
μ	-20 40°C (-4 104°F)	8 95%	0,25 μ ( μ 10.300M, 34.000 )

μ

μ

ISO 9296.

μ

μ

ISO 7779

μ

μ

1 μ , dBA	
	52dBA
( μ )	30dBA

μ

,

μ

μ	PostScript 3, PCL 6
μ	Windows 98 SE/Me, Windows 2000, Windows NT 4.0, Windows XP, Windows Server 2003
	USB 10/100BaseTx Ethernet (μ 1710n)

μ

## MIB

(Management Information Base - MIB)

(

μ

μ

).

μ

μ

,

μ

(

,

MIB

μ

,

).

Dell Laser 1710

μ

μ

μ

Dell OpenManage™, IT Assistant, Hewlett-Packard

OpenView, CA Unicenter, Hewlett-Packard Web JetAdmin, Lexmark MarkVision Professional, ..

μ

Dell Laser 1710

:

- Microsoft Windows 98 2nd Edition
- Microsoft Windows Me
- Microsoft Windows XP
- Microsoft Windows x64
- Microsoft Windows NT 4.00
- Microsoft Windows NT 4.00 Server

- Microsoft Windows 2000 Professional
  - Microsoft Windows 2000 Server
  - Microsoft Windows 2000 Advanced Server
  - Microsoft Windows Server 2003
  - Novell® NetWare® 5.x, 6.x μ μ μ NDPS/iPrint
  - Novell Distributed Print Services™ (NDPS™) 2.0 μ Novell NDPS IP Gateway
  - Red Hat Enterprise 3.0
  - SuSE Enterprise Linux 8.0, 9.0
  - SuSE Linux 9.1, 9.2, 9.3
  - Debian 3.0 rev 2, 3.1
  - Linspire 4.5
  - Red Flag 4.0 ( μ )
  - Mac OS 9.2 OS 10.2
- 

μ



- μ 20 lb (75 g/m<sup>2</sup>).
  - μ laser.
  - μ laser.
  - μ 24 lb (90 g/m<sup>2</sup>). μ
- μ
  - μ μ
  - μ



○ , , , μ

○ μ μ , μ μ

○ μ μ μ μ

○ μ

- μ μ μ 163 g/m<sup>2</sup> μ 3 x 5 in. (76,2 x 127 mm).

μ μ

	μ		
1	, : A4, A5, JIS B5, Letter, Legal, Executive, Folio, Statement : A4, Letter	16–24 lb (60–90 g/m <sup>2</sup> )	250 ( 20 lb) 50 50
550	, : A4, A5, JIS B5, Letter, Legal, Executive, Folio, Statement : A4, Letter	16–24 lb (60–90 g/m <sup>2</sup> )	550 ( 20 lb) 50 50
μ	, A4, A5, JIS B5, Letter, Legal, Executive, Folio, Statement : A4, Letter : Monarch (7 ), 9, Com-10, C5, B5, DL * μ : 3 x 5 in. (76 x 127 mm) μ : 8.5 x 14 in. (216 mm x 356 mm)	16–43 lb (60–163 g/m <sup>2</sup> )	1 ( ) μ
*	μ μ μ ,		

USB	USB 2.0
	IEEE-1284
10/100BaseT Ethernet	CAT-5E

USB-IF

μ

μ

- CE
- EN 55022 ( )
- ENERGY STAR®

(EMI)

AM/FM, (pager) (PCS).

(EMC)

- 
- 
- 
- 

/ Dell

Dell(TM)

- A,
- B,

/

Dell,

Dell.

Dell

[www.dell.com](http://www.dell.com).

Dell

B.

CE ( )

89/336/ **CE** 73/23/ Dell  
Dell

- EN 55022 – " – "
- EN 55024 – " – "
- EN 61000-3-2 – " ( EMC ) - 3: - 2: 16 A )"
- EN 61000-3-3 – " ( EMC ) - 3: - 3: 16 A."
- EN 60950 – " "
- EN 60825-1 - " laser."

: EN 55022 :

- A,
- ,

FCC ICES FCC ICES

FCC ICES

Dell

B

Dell Inc. Products Europe BV, Limerick, Ireland.

CE

1999/5/

CE

EN 55022 (

)

This device belongs to Class B devices as described in EN 55022, unless it is specifically stated that it is a Class A device on the specification label. The following applies to devices in Class A of EN 55022 (radius of protection up to 30 meters). The user of the device is obliged to take all steps necessary to remove sources of interference to telecommunication or other devices.

Pokud není na typovém štítku počítače uvedeno, že spadá do třídy A podle EN 55022, spadá automaticky do třídy B podle EN 55022. Pro zařazení zařízení do třídy A (ochranné písmo 30m) podle EN 55022 platí následující. Dojde-li k rušení telekomunikačních nebo jiných zařízení, je uživatel povinen provést taková opatření, aby rušení odstránil.

μ

μ

μ

μ

μ

μ

μ

μ

μ

μ

16 (A).

PN-EN 55022

"B"

この装置は、情報処理装置等電波障害自主規制協議会 (VCCI) の基準に基づくクラス 1 情報技術装置です。  
この装置を家庭環境で使用すると電波妨害を引き起こすことがあります。この場合には使用者が適切な  
対策を講ずるよう要求されることがあります。

VCCI

ENERGY STAR®

Dell ENERGY STAR®  
(EPA) ENERGY STAR®

Dell.



Dell

Dell

Dell

Dell

Dell.

online

Dell.

Dell

Software & Peripherals (DellWare),

ReadyWare

Custom Factory Integration (CFI/DellPlus),



Dell

Dell

support.dell.com.

WELCOME TO DELL SUPPORT

Dell

• World Wide Web

www.dell.com/

www.dell.com/ap/ ( )

www.euro.dell.com ( )

www.dell.com/la/ ( )

www.dell.com/jp/ ( )

• FTP

ftp.dell.com/

: anonymous

• mobile\_support@us.dell.com

support@us.dell.com

apsupport@dell.com ( )

support.euro.dell.com ( )

- sales@dell.com  
apmarketing@dell.com ( / )
  - info@dell.com
- 

Dell Inc. ( "Dell")  
Dell  
Dell



μ

μ

- Dell /
- Dell GNU General Public License, 2, GNU Lesser General Public License, 2.1
- BSD license and warranty statements

- [BSD License and Warranty Statements](#)
- [GNU License](#)

Dell / GNU  
 Dell  
 GNU  
 Dell  
 Dell  
 GNU  
 Dell  
 Dell  
 Dell  
 GNU  
 Dell, CD Drivers and Utilities ( Contact Dell ( Dell) , )  
 " Dell"